

1W High Power Laser Diode

Description

The SLD323XT is a high power, gain-guided laser diode produced by MOCVD method*1. Compared to the SLD300 Series, this laser diode has a high brightness output with a doubled optical density which can be achieved by QW-SCH structure*2.

Fine adjustment of the oscillation wavelength is possible by controlling the temperature using the built-in TE cooler (Peltier element).

*1 MOCVD: Metal Organic Chemical Vapor Deposition

*2 QW-SCH: Quantum Well Separate Confinement Heterostructure

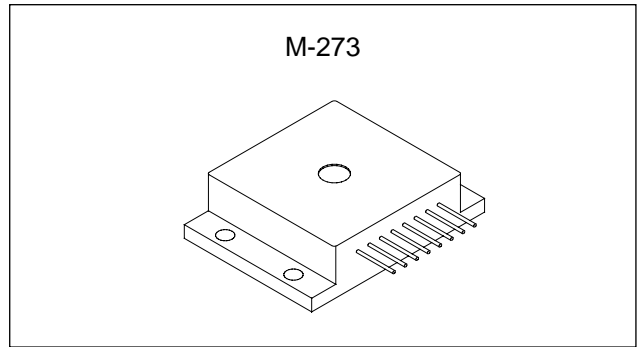

Features

- High power
Recommended optical power output: $P_o = 1.0W$
- Low operating current: $I_{op} = 1.4A$ ($P_o = 1.0W$)
- Flat package with built-in photo diode, TE cooler, and thermistor

Applications

- Solid state laser excitation
- Medical use
- Material processes
- Measurement

Structure

AlGaAs quantum well structure laser diode

Operating Lifetime

MTTF 10,000H (effective value) at $P_o = 1.0W$, $T_{th} = 25^\circ C$

Absolute Maximum Ratings ($T_{th} = 25^\circ C$)

• Optical power output	P_{omax}	1.1	W
• Reverse voltage	V_R	LD 2 PD 15	V
• Operating temperature (T_{th})	T_{opr}	-10 to +30	$^\circ C$
• Storage temperature	T_{stg}	-40 to +85	$^\circ C$

Equivalent Circuit

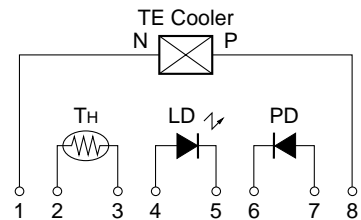

Pin Configuration (Top View)

No.	Function
1	TE cooler (negative)
2	Thermistor lead 1
3	Thermistor lead 2
4	Laser diode (anode)
5	Laser diode (cathode)
6	Photodiode (cathode)
7	Photodiode (anode)
8	TE cooler (positive)

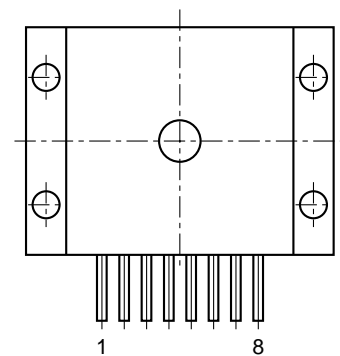

Warranty

This warranty period shall be 90 days after receipt of the product or 1,000 hours operation time whichever is shorter.

Sony Quality Assurance Department shall analyze any product that fails during said warranty period, and if the analysis results show that the product failed due to material or manufacturing defects on the part of Sony, the product shall be replaced free of charge.

Laser diodes naturally have differing lifetimes which follow a Weibull distribution.

Special warranties are also available.

Sony reserves the right to change products and specifications without prior notice. This information does not convey any license by any implication or otherwise under any patents or other right. Application circuits shown, if any, are typical examples illustrating the operation of the devices. Sony cannot assume responsibility for any problems arising out of the use of these circuits.

Electrical and Optical Characteristics

(Tth: Thermistor temperature, Tth = 25°C)

Item	Symbol	Conditions	Min.	Typ.	Max.	Unit	
Threshold current	Ith			0.3	0.5	A	
Operating current	Iop	P _O = 1.0W		1.4	2.0	A	
Operating voltage	Vop	P _O = 1.0W		2.1	3.0	V	
Wavelength*	λp	P _O = 1.0W	790		840	nm	
Monitor current	I _{mon}	P _O = 1.0W V _R = 10V	0.3	1.5	6.0	mA	
Radiation angle	Perpendicular	θ _⊥	P _O = 1.0W	20	30	40	degree
	Parallel	θ//		4	9	17	degree
Positional accuracy	Position	ΔX, ΔY	P _O = 1.0W			±100	μm
	Angle	Δφ _⊥				±3	degree
Differential efficiency	η _D	P _O = 1.0W	0.5	0.9		W/A	
Thermistor resistance	R _{th}	T _{th} = 25°C		10		kΩ	

*** Wavelength Selection Classification**

Type	Wavelength (nm)
SLD323XT-1	795 ± 5
SLD323XT-2	810 ± 10
SLD323XT-3	830 ± 10

Type	Wavelength (nm)
SLD323XT-21	798 ± 3
SLD323XT-24	807 ± 3
SLD323XT-25	810 ± 3

Example of Representative Characteristics

Optical power output vs. Forward current characteristics

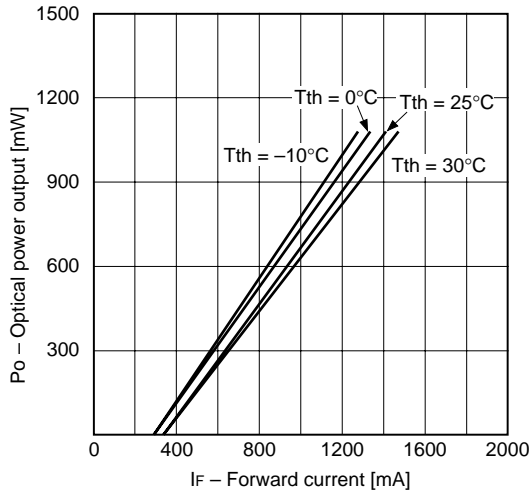

Optical power output vs. Monitor current characteristics

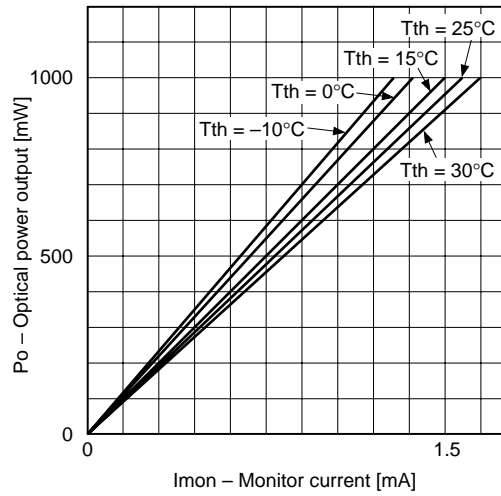

Threshold current vs. Temperature characteristics

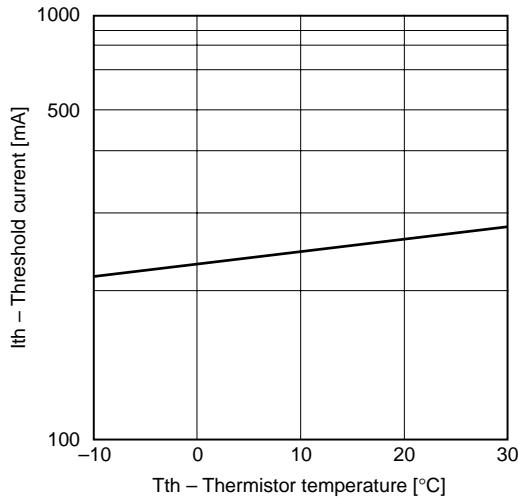

Power dependence of far field pattern (Parallel to junction)

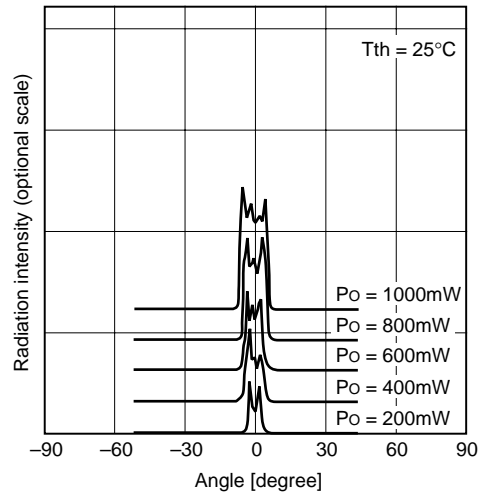

Power dependence of far field pattern (Perpendicular to junction)

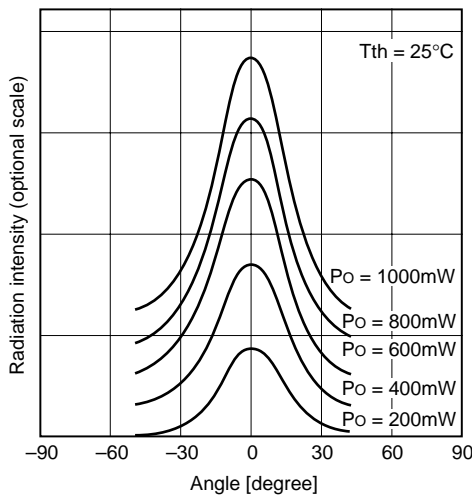

Temperature dependence of far field pattern (Parallel to junction)

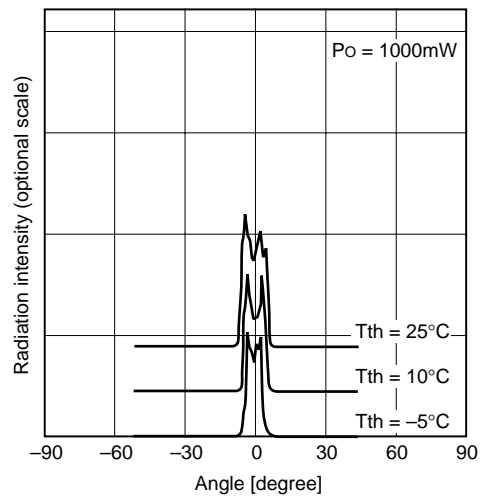

Temperature dependence of far field pattern
(Perpendicular to junction)

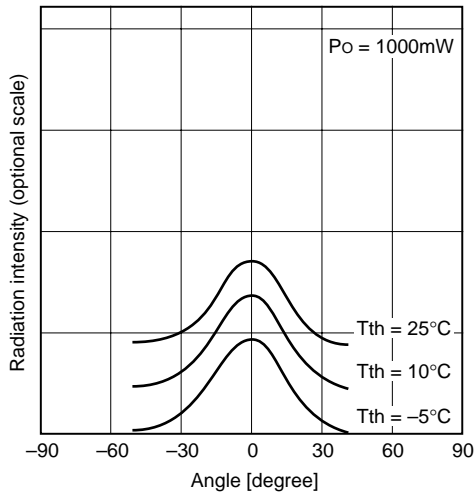

Dependence of wavelength

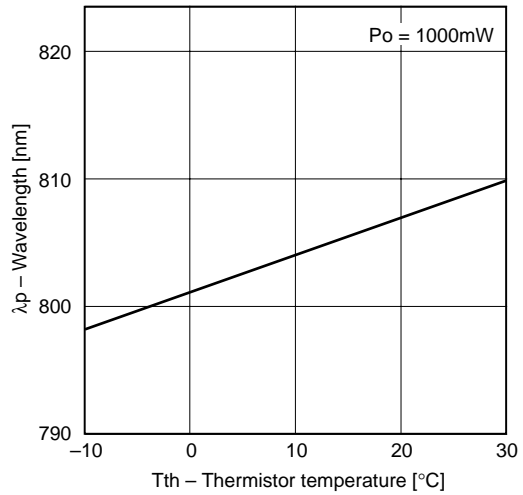

Differential efficiency vs. Temperature characteristics

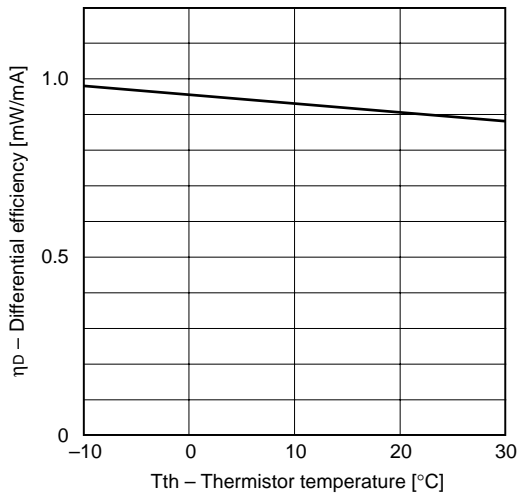

Thermistor characteristics

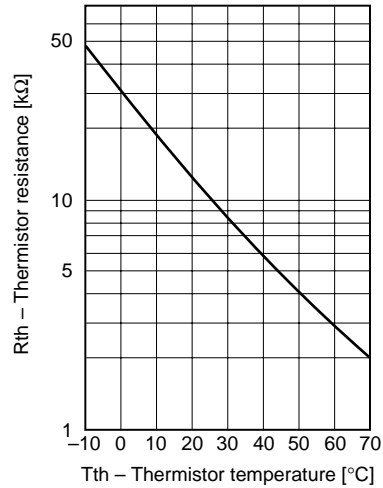

TE cooler characteristics

TE cooler characteristics 1

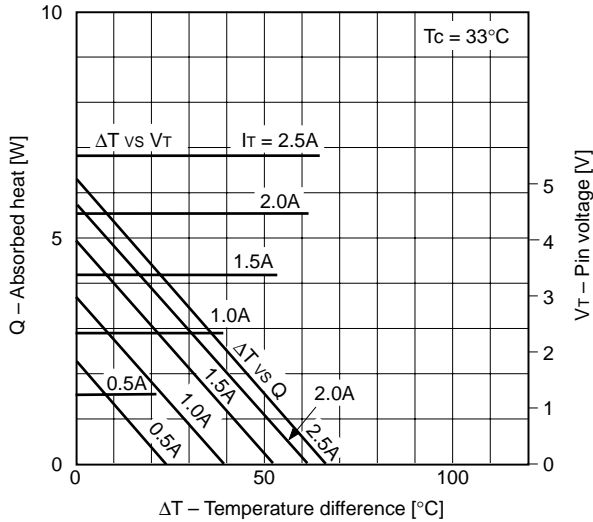

ΔT : T_c - T_{th}
T_{th}: Thermistor temperature
T_c: Case temperature

TE cooler characteristics 2

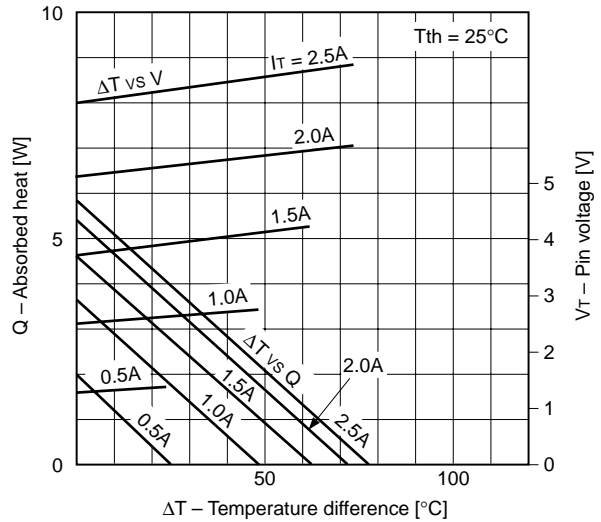

Power dependence of spectrum

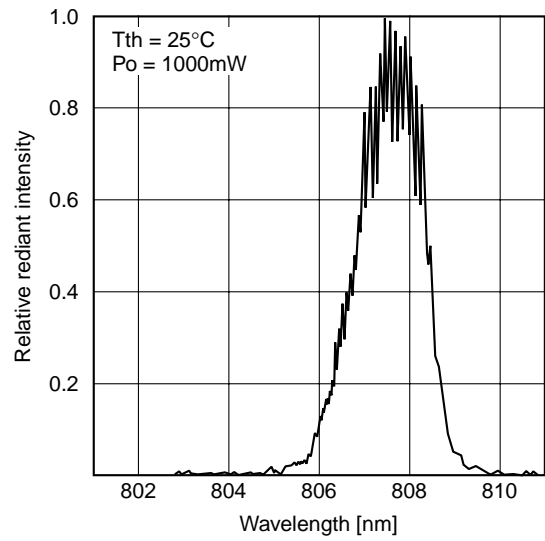
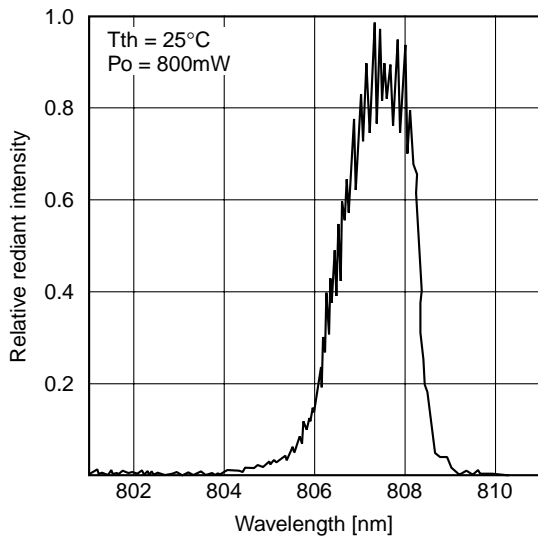
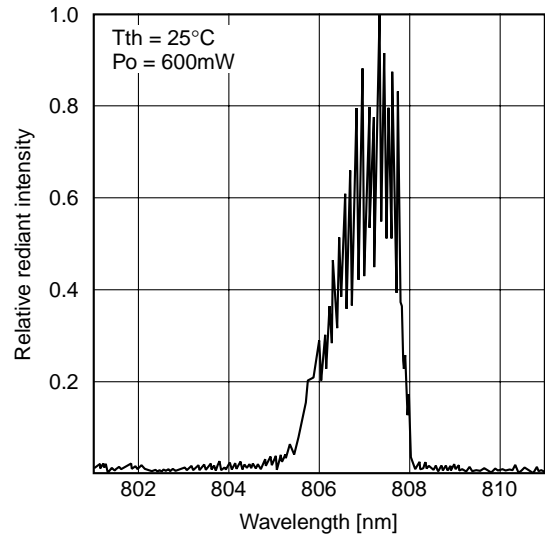
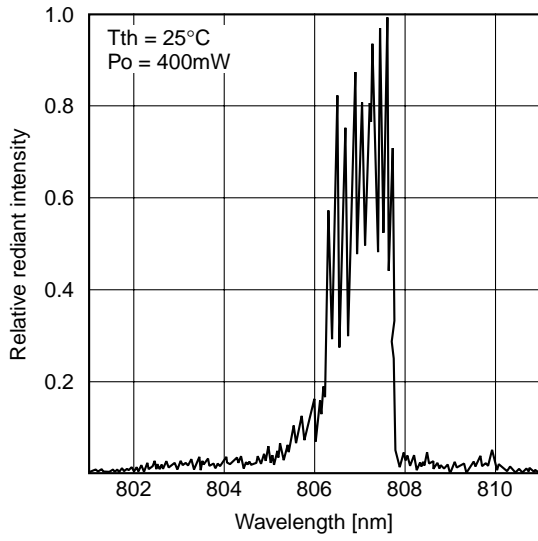

Temperature dependence of spectrum ($P_o = 1000\text{mW}$)

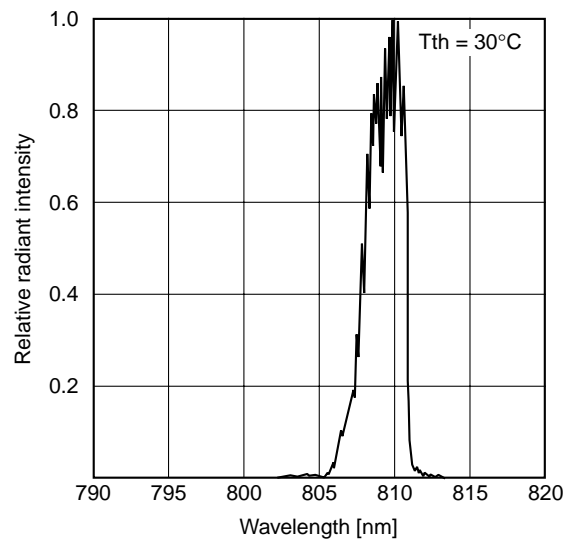
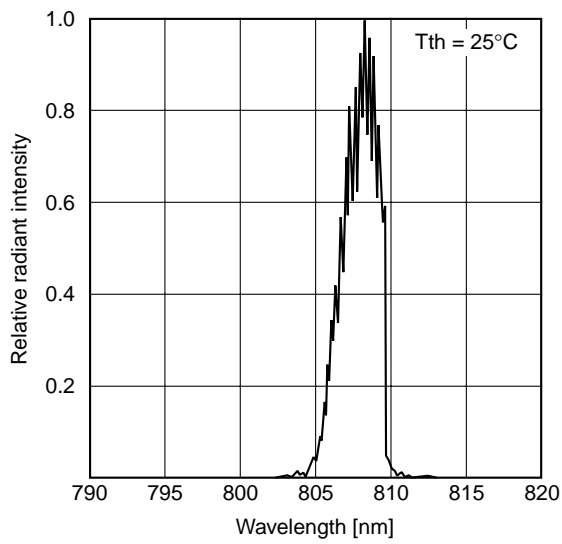
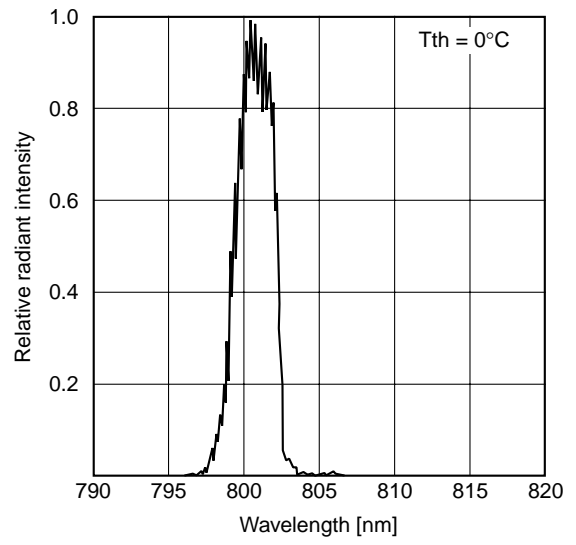
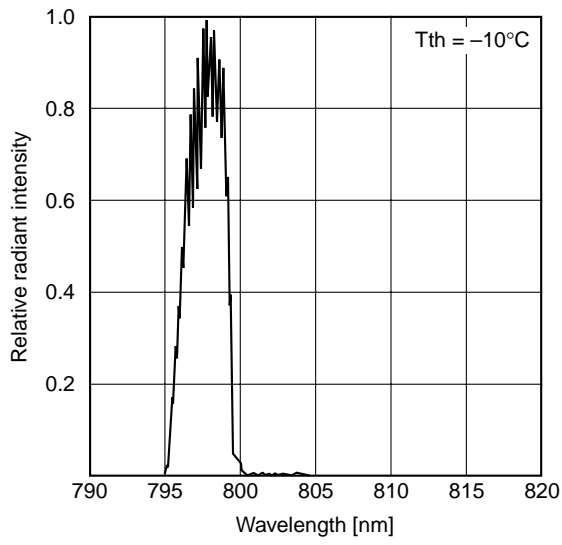

Notes on Operation

Care should be taken for the following points when using this product.

- (1) This product corresponds to a Class 4 product under IEC60825-1 and JIS standard C6802 "Laser Product Emission Safety Standards".

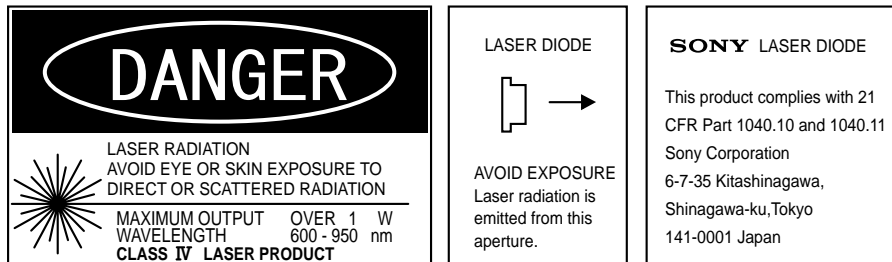

- (2) Eye protection against laser beams

Take care not to allow laser beams to enter your eyes under any circumstances.

For observing laser beams, ALWAYS use safety goggles that block laser beams. Usage of IR scopes, IR cameras and fluorescent plates is also recommended for monitoring laser beams safely.

- (3) Gallium Arsenide

This product uses gallium arsenide (GaAs). This is not a problem for normal use, but GaAs vapors may be potentially hazardous to the human body. Therefore, never crush, heat to the maximum storage temperature or higher, or place the product in your mouth.

In addition, the following disposal methods are recommended when disposing of this product.

1. Engaging the services of a contractor certified in the collection, transport and intermediate treatment of items containing arsenic.
2. Managing the product through to final disposal as specially managed industrial waste which is handled separately from general industrial waste and household waste.

- (4) Prevention of surge current and electrostatic discharge

Laser diodes are most sensitive to electrostatic discharge among semiconductors. When a large current is passed through the laser diode for even an extremely short time, the strong light emitted from the laser diode promotes deterioration and then destruction of the laser diode. Therefore, note that surge current should not flow to the laser diode driving circuit from switches and others. Also, if the laser diode is handled carelessly, it may be destroyed instantly because electrostatic discharge is easily applied by a human body. Therefore, be extremely careful about overcurrent and electrostatic discharge.

- (5) Use for special applications

This product is not designed or manufactured for use in equipment used under circumstances where failure may pose a risk to life and limb, or result in significant material damage, etc.

Consult your Sony sales representative when investigating use for medical, vehicle, nuclear power control or other special applications. Also, use the power supply that was designed not to exceed the optical power output specified at the absolute maximum ratings.

Package Outline

Unit: mm

M-273 (LO-10)

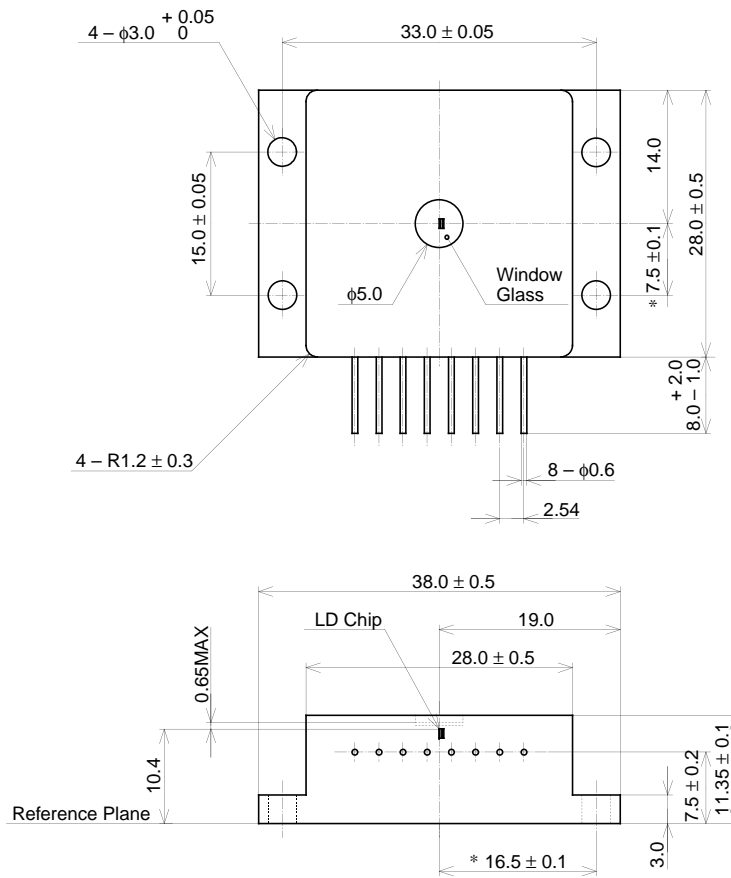

*Distance between pilot hole and emitting area

PACKAGE STRUCTURE

SONY CODE	M-273(LO-10)
EIAJ CODE	_____
JEDEC CODE	_____

PACKAGE MASS	43g
--------------	-----